



Operating And Maintaining Underground Storage Tank Systems

Practical Help And Checklists

EPA wrote this booklet for owners and operators of underground storage tanks (USTs).

This booklet describes the 2015 revised *federal* UST regulation. Many states and territories (referred to as states in this booklet) have state program approval from EPA. To find a list of states with state program approval, see www.epa.gov/ust/state-underground-storage-tank-ust-programs.

If your UST systems are located in a state *with* state program approval, your requirements may be different from those identified in this booklet. To find information about your state's UST regulation, contact your implementing agency or visit its website. You can find links to state UST websites at www.epa.gov/ust/underground-storage-tank-ust-contacts#states.

If your UST systems are located in a state *without* state program approval, both the requirements in this booklet and the state requirements apply to you.

If your UST systems are located in Indian country, the requirements in this booklet apply to you.

Free Publications About UST Requirements

Download or read *Operating And Maintaining Underground Storage Tank Systems* on EPA's underground storage tank (UST) website at www.epa.gov/ust. Order printed copies of many, but not all, of our documents from the National Service Center for Environmental Publications (NSCEP), EPA's publication distributor: write to NSCEP, PO Box 42419, Cincinnati, OH 45242; call NSCEP's toll-free number 800-490-9198; or fax your order to NSCEP 301-604-3408.

Image credits:

MVI Field Services (inspector on cover and page 52)

Highland Tank & Manufacturing Company (steel tanks on cover and in headers)

OPW (spill bucket on page 31, automatic shutoff device on page 35, ball float valve on page 39)

Federated Environmental Associates, Inc. (delivery and under-dispenser containment on cover)

Contents



How To Use This Booklet.....	1
Section 1: Identifying The Equipment At Your UST Facility	3
Section 2: Release Detection	5
Section 3: Suspected Or Confirmed Releases	26
Section 4: Spill And Overfill Protection.....	30
Section 5: Corrosion Protection	43
Section 6: Walkthrough Inspections.....	52
Section 7: For More Information.....	55

Disclaimer

This document provides information on operating and maintaining underground storage tank (UST) systems. The document is not a substitute for U.S. Environmental Protection Agency regulations nor is it a regulation itself — it does not impose legally binding requirements.

For regulatory requirements regarding UST systems, refer to the federal regulation governing UST systems (40 CFR part 280).

How To Use This Booklet



Who Should Read This Booklet?

This booklet is for owners and operators of underground storage tank (UST) systems regulated under 40 CFR part 280.

You are responsible for making sure your USTs do not leak. This booklet can help you meet your UST responsibilities.

How Can This Booklet Help You?

This booklet can help you:

- Understand the 2015 UST regulation and its impact on regular operation and maintenance (O&M) procedures.
- Identify and understand the O&M procedures you should follow routinely to make sure your USTs do not leak and possibly damage the environment or endanger human health. These O&M procedures will help you avoid cleanup costs and liability concerns.
- Stay in compliance with EPA's UST O&M requirements.
- Identify O&M records you must keep on file.

What Should You Do With Each Section Of This Booklet?

Read through each section carefully and use the checklists to help you establish clear O&M procedures.

By identifying and understanding the O&M tasks you should perform routinely, you will help ensure timely repair or replacement of components when problems are identified.

Throughout this document, bold type and orange updated boxes indicate new requirements in the 2015 UST regulation.

Releases from USTs can threaten human health and the environment, contaminating both soil and groundwater supplies. As of 2015, more than 525,000 UST releases have been confirmed.

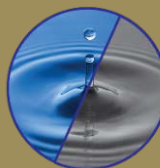

About half
of the United States
population uses
groundwater as a source
of drinking water.

How Can You Use The Checklists Effectively?

You can select the specific mix of checklists that matches your UST facility. Once you identify your site-specific group of checklists, use them to perform operation and maintenance activities at your UST facility. Make several copies and complete them periodically.

By using these checklists, you can track your O&M activities and know you have done what was necessary to properly operate and maintain your UST system. Proper O&M activities help reduce releases of regulated substances to the environment.

Check With Your Implementing Agency

Many states and territories (referred to as states in this booklet) have state program approval from EPA. To find a list of states with state program approval, see www.epa.gov/ust/state-underground-storage-tank-ust-programs.

If your UST systems are located in a state *with* state program approval, your requirements may be different from those identified in this booklet. Check with the state UST program in the state where your USTs are located for your state's requirements.

If your UST systems are located in a state *without* state program approval, both the requirements in this booklet and the state requirements apply to you.

If your UST systems are located in Indian country, the requirements in this booklet apply to you.

Key Terms

An UST is a storage tank and underground piping connected to the tank that has at least 10 percent of its combined volume underground. The federal regulation applies only to USTs storing petroleum, including biofuel blends, and certain hazardous substances.

O&M means operation and maintenance procedures that owners and operators must follow to keep UST systems from leaking, which can result in costly cleanups.

Your implementing agency may be the state UST agency, EPA, or a local UST agency.

A list of state contacts can be found at www.epa.gov/ust/underground-storage-tank-ust-contacts#states.

Section 1: Identifying The Equipment At Your UST Facility



UST Equipment Checklist

Use the checklist on page 4 to identify UST equipment at your facility. Each part of the checklist refers you to the appropriate section of this O&M booklet for relevant information. After you identify your equipment, proceed to the appropriate sections and identify the O&M actions necessary for your specific UST system.

Problems Completing This Checklist

If you have trouble completing this checklist or others in this booklet, you can contact:

- Your UST contractor, the vendor of your UST equipment, and the manufacturer of your UST equipment for help. Look through your records for contact information. You may also use the contacts provided in Section 7.
- Your implementing agency may be able to help you identify equipment or sources of information about your UST equipment. Identify additional or different O&M procedures between those of your implementing agency and those presented in this booklet. See Section 7 for implementing agency contact information.

Remember Compatibility

If you store regulated substances containing greater than 10 percent ethanol or greater than 20 percent biodiesel (or any other regulated substance identified by your state UST agency), you must notify your implementing agency at least 30 days prior to switching to the fuel. You must also keep records demonstrating you meet the compatibility requirement. Keep these records for as long as the UST system stores the regulated substance.

General Facility Information (optional)

Facility Name

Facility ID #

Release Detection (Section 2)

Check at least one for each tank:

Tank 1

Tank 2

Tank 3

Tank 4

A. Release Detection For Tanks¹

		Tank 1	Tank 2	Tank 3	Tank 4
	Automatic tank gauging (ATG) system				
	Interstitial monitoring (with secondary containment)				
	Statistical inventory reconciliation (SIR)				
	Continuous in-tank leak detection (CITLD)				
	Vapor monitoring				
	Groundwater monitoring				
	Inventory control and tank tightness testing (TTT) ²				
	Manual tank gauging only ³				
	Manual tank gauging and tank tightness testing (TTT) ⁴				
	Other release detection method (please specify)				

1. If you install or replace a tank after April 11, 2016, it must have secondary containment and interstitial monitoring.

2. Allowed only for 10 years after the tank was installed. TTT required every five years.

3. Allowed only for tanks of 1,000 gallon capacity or less, with specified diameters.

4. Allowed only for tanks of 2,000 gallon capacity or less and only for 10 years after tank was installed. TTT required every five years.

B. Release Detection For Pressurized Piping¹

		Tank 1	Tank 2	Tank 3	Tank 4
A (Automatic Line Leak Detectors)	Automatic flow restrictor				
	Automatic shutoff device				
	Audible or visual alarm				
B	Annual line tightness test				
	Monthly monitoring ²				

1. If you install or replace piping after April 11, 2016, it must have secondary containment and interstitial monitoring and have an automatic line leak detector.

2. Monthly monitoring for piping includes interstitial monitoring, vapor monitoring, groundwater monitoring, SIR, and CITLD.

C. Release Detection For Suction Piping¹

		Tank 1	Tank 2	Tank 3	Tank 4
	Line tightness testing every three years				
	Monthly monitoring ²				
	No release detection (safe suction) ³				

1. If you install or replace piping after April 11, 2016, it must have secondary containment and interstitial monitoring (except for safe suction piping).

2. Monthly monitoring for piping includes interstitial monitoring, vapor monitoring, groundwater monitoring, and other accepted methods (such as SIR and electronic line leak detectors).

3. No release detection required only if it can be verified that you have a safe suction piping system with the following characteristics: only one check valve per line located directly below the dispenser; piping sloping back to the tank; and system must operate under atmospheric pressure.

Spill And Overfill Protection (Section 4)

		Tank 1	Tank 2	Tank 3	Tank 4
	Spill catchment basin or spill bucket (check for each tank)				
	Automatic shutoff device				
	Overfill alarm				
	Ball float valve ¹				

1. Ball float valves may not be used to meet this requirement when overfill prevention is installed or replaced after October 13, 2015.

Corrosion Protection (Section 5)

A. Corrosion Protection For Tanks

		Tank 1	Tank 2	Tank 3	Tank 4
	Coated and cathodically protected steel				
	Noncorrodible material (such as fiberglass reinforced plastic)				
	Steel jacketed or clad with noncorrodible material				
	Cathodically protected noncoated steel				
	Internally lined tank				
	Other method (please specify)				

B. Corrosion Protection For Piping

		Tank 1	Tank 2	Tank 3	Tank 4
	Coated and cathodically protected steel				
	Noncorrodible material (such as fiberglass reinforced plastic or flexible plastic)				
	Cathodically protected noncoated metal				
	Other method (please specify)				

Section 2: Release Detection

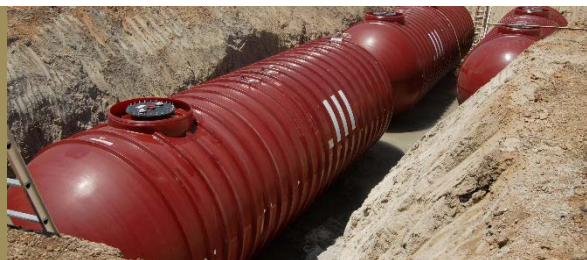

What Are Your Release Detection Options?

For tanks installed on or before April 11, 2016, you can use any of these release detection methods:

- Automatic tank gauging systems
- Interstitial monitoring (with secondary containment)
- Statistical inventory reconciliation
- Continuous in-tank leak detection
- Vapor monitoring
- Groundwater monitoring
- Inventory control with tank tightness testing
- Manual tank gauging
- Manual tank gauging with tank tightness testing
- Other methods meeting performance standards or approved by the implementing agency

For underground piping installed on or before April 11, 2016, you may use any of the release detection methods listed above that are appropriate for piping or conduct periodic line tightness testing. In addition, pressurized piping must have an automatic line leak detector.

UPDATED

Tanks and piping installed or replaced after April 11, 2016 must have secondary containment with interstitial monitoring, except for piping that is considered safe suction piping. Pressurized piping must continue to have an automatic line leak detector.

Suction piping is considered safe suction piping if it:

- Is below-grade piping that operates under atmospheric pressure;
- Slopes enough so that the product in the pipe can drain back into the tank when suction is released; and
- Has only one check valve, which is as close as possible beneath the pump in the dispensing unit.

Safe suction piping is not required to have release detection.

The 2015 UST regulation removes the deferral for field-constructed tanks and airport hydrant systems, making them subject to all of the UST requirements. Because these UST systems can be large and unique, some requirements are different from those described in this booklet. Therefore, these systems are not covered in this booklet. Please see EPA's field-constructed tanks and airport hydrant systems website at www.epa.gov/ust/field-constructed-tanks-and-airport-hydrant-systems-2015-requirements.

No later than October 13, 2018, emergency generator USTs installed on or before October 13, 2015 must meet the release detection requirements described in this booklet. Emergency generators installed after October 13, 2015 must meet the release detection requirements at installation.

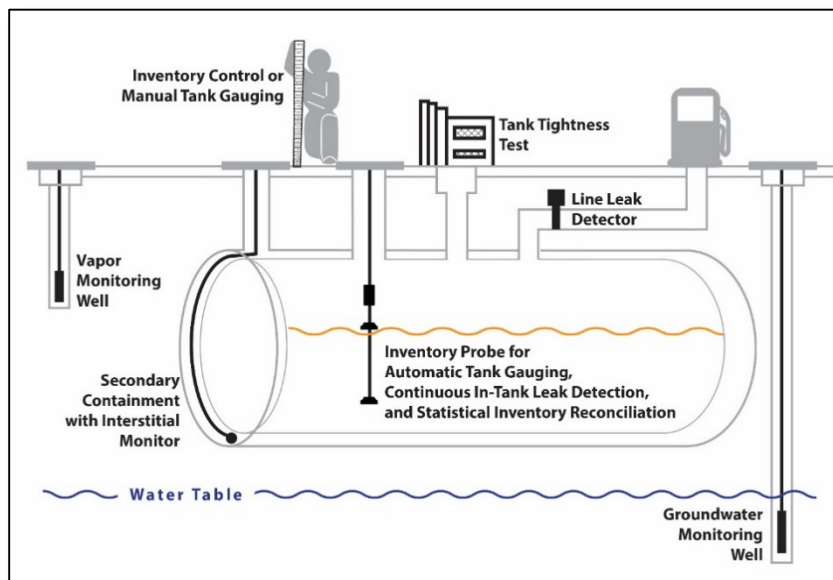

What Are Your Existing Release Detection Requirements?

You must use proper release detection methods to determine at least every 30 days whether your tank and piping are leaking.

Your release detection method must be able to detect a leak from any portion of the tank and connected underground piping that routinely contains product.

You must keep the following records:

- Proof that performance claims, including probabilities of detection and false alarm, are met and the means by which performance was determined by either the equipment manufacturer or installer. You must maintain these records for at least five years.
- Results of any sampling, testing, or monitoring, except tank tightness tests, must be maintained for at least one year. You must maintain results of tank tightness tests until the next test is conducted.
- All calibration, maintenance, and repair of release detection equipment permanently located on site must be maintained for at least one year after servicing work is completed.
- Any schedules of required calibration and maintenance provided by equipment manufacturers must be retained for five years from the date of installation.

What Are Your Additional Release Detection Requirements?

UPDATED

No later than October 13, 2018, you must conduct your first annual test of your release detection equipment for proper operation. The testing must be conducted according to one of the following: manufacturer's instructions; a code of practice developed by a nationally recognized association or independent testing laboratory; or requirements your implementing agency determines are no less protective of human health and the environment than the other two options. Minimum requirements for testing various release detection components are covered under each release detection checklist. You must keep records of this testing for at least three years. See the sample annual release detection testing recordkeeping form on page 10.

UPDATED

No later than October 13, 2018, you must conduct your first periodic walkthrough inspection of your release detection equipment. You must keep records of these inspections for at least one year. See more information about walkthrough inspections in Section 6.

UPDATED

No later than October 13, 2018, if you use groundwater or vapor monitoring for release detection, you must demonstrate proper installation and performance through a site assessment. You must maintain the site assessment for as long as the method is used for release detection at your facility. Site assessments completed after October 13, 2015, must be signed by a licensed professional.

What About Compatibility?

UPDATED

If you store regulated substances containing greater than 10 percent ethanol or greater than 20 percent biodiesel or any other regulated substance identified by your implementing agency, keep records demonstrating compatibility of the release detection components, such as probes and sensors, in contact with the regulated substance for as long as the UST system stores the regulated substance.

Remember, your release detection method must meet specific performance requirements relating to its ability to detect a release. You must also ensure you use a method appropriate to your UST system and the product you store.

Do You Know If Your Release Detection Meets Performance Requirements?

Release detection must meet specific performance requirements. UST system owners and operators must keep written verification of equipment performance. Equipment manufacturers or installers provide this verification. Some equipment vendors or manufacturers supply their own performance documentation, but more often an impartial third party is paid to test the release detection equipment and certify that performance requirements are met. An independent workgroup of release detection experts periodically reviews and maintains a list of submitted third-party certifications, thus providing a free and reliable list of evaluations of third-party certifications for various release detection equipment. Frequently updated, this list is available at www.nwglde.org; the publication is *List Of Leak Detection Evaluations For Storage Tank Systems*. If you cannot find the performance documentation, contact your implementing agency; see Section 7 for contact information.

You should check the performance documentation to ensure your method is appropriate for use with your UST system equipment. By checking the documentation, you may discover the method you use has not been approved for use with the type of tank or piping you have. For example, you may learn from the documentation that your method will not work with manifolded tanks, certain products, high throughput, or certain tank sizes. That is why you must make sure your release detection method has clear performance documentation stating it will work effectively at your site with its specific characteristics.

What Are Your Release Detection O&M Responsibilities At Your UST Site?

If you do not understand your release detection O&M responsibilities and do not know what O&M tasks you must routinely perform, your UST site could become contaminated through spills, overfills, or releases from UST equipment. To avoid these problems use the checklists on the following pages, which describe each type of release detection method, discuss actions necessary for proper O&M, and note the records you should keep.

Locate the methods of release detection you are using at your facility, review these pages, and periodically review the checklists. You might want to print the checklists and periodically complete them later.

If you have questions about your release detection system, review your owner's manual or call the vendor of your system. Your implementing agency may be able to provide assistance as well.

You will find sample release detection recordkeeping forms in this section. Keeping these records increases the likelihood that you are conducting good O&M and providing effective release detection at your UST site. For example, the following page has a sample recordkeeping form for your required annual release detection testing.

If you ever suspect or confirm a release, refer to Section 3. Never ignore release detection alarms or failed release detection tests. Treat them as potential leaks.

Sample Annual Release Detection Testing Recordkeeping Form

Date(s) of annual release detection operation test: _____

Component Tested	Name Of Tester	Meets Criteria? (Y/N)	Needs Action? (Y/N)	Action Taken To Correct Issue
Automatic tank gauge and other controllers: test alarm; verify system configuration; test battery backup.				
Probes and sensors: inspect for residual buildup; ensure floats move freely; ensure shaft is not damaged; ensure accessible cables are free of kinks and breaks; test alarm operability and communication with controller.				
Automatic line leak detector: test to ensure device can detect 3 gallons per hour at 10 pounds per square inch (or equivalent) within one hour by simulating a leak.				
Vacuum pumps and pressure gauges: ensure proper communication with sensors and controller.				
Hand-held electronic sampling equipment associated with groundwater and vapor monitoring: ensure proper operation.				
Other Components Tested:				

Notes:

Release Detection Tester Signature

Date

Keep this record for three years.

Checklist For Automatic Tank Gauging Systems (For Tanks Only)

Automatic Tank Gauging Systems (For Tanks Only)	
Description	<p>An automatic tank gauging (ATG) system consists of a probe permanently installed in a tank and wired to a monitor to provide information on product level and temperature. ATG systems automatically calculate the changes in product volume that can indicate a leaking tank.</p>
<p>Perform These O&M Actions</p>	<ul style="list-style-type: none"> <input type="checkbox"/> Use your ATG system to test for leaks at least every 30 days. <input type="checkbox"/> Make sure the amount of product in your tank is sufficient to run the ATG leak test. The tank must contain a minimum amount of product to perform a valid leak test. One source for determining that minimum amount is the performance documentation for your release detection equipment. <input type="checkbox"/> No later than October 13, 2018, you must begin inspecting and testing your ATG system every year. At a minimum, test the alarm, battery back-up, and verify the system configuration. For probes and sensors, you must inspect for residual build-up, ensure floats move freely, ensure the shaft is not damaged, ensure accessible cables are free of kinks and breaks, and test alarm operability and communication with controller. <input type="checkbox"/> No later than October 13, 2018, you must begin performing periodic walkthrough inspections. See Section 6 for more information about these required walkthrough inspections. <input type="checkbox"/> If your ATG ever fails a test or indicates a release, see Section 3 for information on what to do next. <input type="checkbox"/> Make sure employees who run, monitor, or maintain the release detection system know exactly what they have to do and to whom to report problems. No later than October 13, 2018, UST owners must have designated and trained operators. Most states already require operator training.
<p>Keep These O&M Records</p>	<ul style="list-style-type: none"> <input type="checkbox"/> Keep results of your 30-day release detection monitoring for at least one year. Your monitoring equipment may provide printouts that can be used as records. See page 25 for a sample 30 day recordkeeping form. <input type="checkbox"/> Keep results for your annual ATG system operation tests for at least three years. <input type="checkbox"/> Keep all records of calibration, maintenance, and repair of your release detection equipment for at least one year. <input type="checkbox"/> Keep any schedules of required calibration and maintenance provided by the release detection equipment manufacturer for at least five years from the date of installation. <input type="checkbox"/> Keep all performance claims supplied by the installer, vendor, or manufacturer for at least five years. <input type="checkbox"/> Keep your periodic walkthrough inspection records for at least one year. <input type="checkbox"/> If you store regulated substances containing greater than 10 percent ethanol or greater than 20 percent biodiesel or any other regulated substance identified by your implementing agency, keep records demonstrating compatibility for as long as the UST system stores the regulated substance.

UPDATED

UPDATED

UPDATED

UPDATED

UPDATED

UPDATED

Checklist For Secondary Containment With Interstitial Monitoring (For Tanks And Piping)

Secondary Containment With Interstitial Monitoring (For Tanks And Piping)	
Description	<p>Secondarily-contained UST systems have an inner and outer barrier with an interstitial space that is monitored for leaks. This term includes containment sumps when used for interstitial monitoring of piping. Examples of secondary containment include an outer tank or piping wall, an excavation liner, and a bladder inside an UST.</p>
<p>UPDATED</p> <p>UPDATED</p> <p>UPDATED</p> <p>UPDATED</p> <p>UPDATED</p>	<p>Perform These O&M Actions</p> <ul style="list-style-type: none"> <input type="checkbox"/> Use your release detection system to test for leaks at least every 30 days. <input type="checkbox"/> No later than October 13, 2018, you must begin inspecting and testing your release detection system every year. You must inspect probes and sensors for residual build-up, ensure floats move freely, ensure the shaft is not damaged, ensure accessible cables are free of kinks and breaks, and test alarm operability and communication with the controller. <input type="checkbox"/> No later than October 13, 2018, you must begin testing all containment sumps used for piping interstitial monitoring every three years for liquid tightness or use a double-walled containment sump with annual interstitial monitoring. <input type="checkbox"/> No later than October 13, 2018, you must begin performing periodic walkthrough inspections. See Section 6 for more information about these required walkthrough inspections. <input type="checkbox"/> If you repair any secondary containment areas, you must test them for tightness within 30 days after the repair. <input type="checkbox"/> If your release detection ever fails a test or indicates a release, see Section 3 for information on what to do next. <input type="checkbox"/> Make sure employees who run, monitor, or maintain the release detection system know exactly what they have to do and to whom to report problems. No later than October 13, 2018, UST owners must have designated and trained operators. Most states already require operator training.
<p>UPDATED</p> <p>UPDATED</p> <p>UPDATED</p> <p>UPDATED</p>	<p>Keep These O&M Records</p> <ul style="list-style-type: none"> <input type="checkbox"/> Keep results of your 30-day release detection monitoring for at least one year. Your monitoring equipment may provide printouts that can be used as records. See page 25 for a sample 30 day recordkeeping form. <input type="checkbox"/> Keep results for your annual release detection system operation tests for at least three years. <input type="checkbox"/> Keep all records of calibration, maintenance, and repair of your release detection equipment for at least one year. <input type="checkbox"/> Keep any schedules of required calibration and maintenance provided by the release detection equipment manufacturer for at least five years from the date of installation. <input type="checkbox"/> Keep all performance claims supplied by the installer, vendor, or manufacturer for at least five years. <input type="checkbox"/> For containment sump and secondary containment equipment inspections that are part of the periodic walkthrough inspection requirement, keep records of the walkthrough inspection for at least one year. <input type="checkbox"/> For containment sumps used for interstitial monitoring of piping, keep records of containment sump testing for three years or keep documentation showing the containment sump is double-walled and the integrity of both walls is periodically monitored for as long as containment sump testing is not performed. See page 33 for a sample recordkeeping form for the test. <input type="checkbox"/> If you store regulated substances containing greater than 10 percent ethanol or greater than 20 percent biodiesel or any other regulated substance identified by your implementing agency, keep records demonstrating compatibility for as long as the UST system stores the regulated substance.

Checklist For Statistical Inventory Reconciliation (For Tanks And Piping)

Statistical Inventory Reconciliation (For Tanks And Piping)	
<p>Description</p>	<p>Statistical inventory reconciliation (SIR) is typically a method in which a trained professional uses sophisticated computer software to conduct a statistical analysis of inventory, delivery, and dispensing data. You must supply the professional with data every month. Computer programs enable an owner or operator to perform SIR. In either case, the result of the analysis may be pass, inconclusive, or fail.</p>
<p>Perform These O&M Actions</p>	<ul style="list-style-type: none"> <input type="checkbox"/> Supply daily inventory data to your SIR vendor at least every 30 days or use your computer software at least every 30 days to test your tank for leaks. <input type="checkbox"/> If your SIR method ever fails a test or indicates a release, see Section 3 for information on what to do next. <input type="checkbox"/> If you receive an inconclusive result, you and your SIR vendor must correct the problem and use another method of release detection if SIR results are inconclusive. An inconclusive result means that you have not performed release detection for that month. If you cannot resolve the problem, treat the inconclusive result as a suspected leak and refer to Section 3. <input type="checkbox"/> No later than October 13, 2018, you must begin performing periodic walkthrough inspections. See Section 6 for more information about these required walkthrough inspections. <input type="checkbox"/> No later than October 13, 2018, you must begin inspecting and testing your release detection system every year. If you use an ATG system to gather SIR data, annually test your ATG system. At a minimum, test the alarm, battery backup, and verify the system configuration. For probes and sensors, you must inspect for residual buildup, ensure floats move freely, ensure the shaft is not damaged, ensure accessible cables are free of kinks and breaks, and test alarm operability and communication with controller. <input type="checkbox"/> If you stick your tank to gather data for the SIR vendor or your software, make sure your stick can measure to one-eighth of an inch and can measure the level of product over the full range of the tank's height. <input type="checkbox"/> Make sure employees who run, monitor, or maintain the release detection system know exactly what they have to do and to whom to report problems. No later than October 13, 2018, UST owners must have designated and trained operators. Most states already require operator training.
<p>Keep These O&M Records</p>	<ul style="list-style-type: none"> <input type="checkbox"/> Keep results of your 30-day release detection monitoring for at least one year. <input type="checkbox"/> Keep results for your annual release detection system operation tests for at least three years. <input type="checkbox"/> Keep all records of calibration, maintenance, and repair of your release detection equipment for at least one year. <input type="checkbox"/> Keep any schedules of required calibration and maintenance provided by the release detection equipment manufacturer for at least five years from the date of installation. <input type="checkbox"/> Keep all performance claims supplied by the installer, vendor, or manufacturer for at least five years. This includes the documentation of the SIR method discussed above. <input type="checkbox"/> Keep your periodic walkthrough inspection records for at least one year. <input type="checkbox"/> If you store regulated substances containing greater than 10 percent ethanol or greater than 20 percent biodiesel or any other regulated substance identified by your implementing agency, keep records demonstrating compatibility for as long as the UST system stores the regulated substance.

UPDATED

UPDATED

UPDATED

UPDATED

UPDATED

UPDATED

Checklist For Continuous In-Tank Leak Detection

Continuous In-Tank Leak Detection	
Description	<p>Continuous in-tank leak detection (CITLD) encompasses all statistically based methods where the system incrementally gathers measurements on an uninterrupted or nearly uninterrupted basis to determine a tank's leak status. There are two major groups that fit into this category: continuous statistical leak detection (also referred to as continuous automatic tank gauging methods) and continual reconciliation. Both groups typically use sensors permanently installed in the tank to obtain inventory measurements. They are combined with a microprocessor in the ATG system or other control console that processes the data. Continual reconciliation methods are further distinguished by their connection to dispensing meters that allow for automatic recording and use of dispensing data in analyzing tanks' leak status.</p> <p>CITLD must operate on an uninterrupted basis or operate within a process that allows the system to gather incremental measurements to determine the leak status of the tank at least once every 30 days.</p>
<p>UPDATED</p> <p>UPDATED</p> <p>Perform These O&M Actions</p>	<ul style="list-style-type: none"> <input type="checkbox"/> No later than October 13, 2018, you must begin performing periodic walkthrough inspections. See Section 6 for more information about these required walkthrough inspections. <input type="checkbox"/> No later than October 13, 2018, you must begin inspecting and testing your release detection system every year. At a minimum, test the alarm, battery backup, and verify the system configuration. For probes and sensors, you must inspect for residual buildup, ensure floats move freely, ensure the shaft is not damaged, ensure accessible cables are free of kinks and breaks, and test alarm operability and communication with controller. <input type="checkbox"/> If your CITLD method ever fails a test or indicates a release, see Section 3 for information on what to do next. <input type="checkbox"/> Make sure employees who run, monitor, or maintain the release detection system know exactly what they have to do and to whom to report problems. No later than October 13, 2018, UST owners must have designated and trained operators. Most states already require operator training.
<p>UPDATED</p> <p>Keep These O&M Records</p> <p>UPDATED</p> <p>UPDATED</p>	<ul style="list-style-type: none"> <input type="checkbox"/> Keep results of your 30-day release detection monitoring for at least one year. Your monitoring equipment may provide printouts that can be used as records. A sample 30 day recordkeeping form is provided on page 25. <input type="checkbox"/> Keep results for your annual release detection system operation tests for at least three years. <input type="checkbox"/> Keep all records of calibration, maintenance, and repair of your release detection equipment for at least one year. <input type="checkbox"/> Keep any schedules of required calibration and maintenance provided by the release detection equipment manufacturer for at least five years from the date of installation. <input type="checkbox"/> Keep all performance claims supplied by the installer, vendor, or manufacturer for at least five years. <input type="checkbox"/> Keep your periodic walkthrough inspection records for at least one year. <input type="checkbox"/> If you store regulated substances containing greater than 10 percent ethanol or greater than 20 percent biodiesel or any other regulated substance identified by your implementing agency, keep records demonstrating compatibility for as long as the UST system stores the regulated substance.

Checklist For Vapor Monitoring (For Tanks And Piping)

Vapor Monitoring (For Tanks And Piping)	
Description	<p>Vapor monitoring checks for leaks by measuring product vapors in the soil at the UST site. A site assessment determines the number and placement of monitoring wells. Please note that vapor monitoring will not work well with substances, such as diesel fuel, that do not easily vaporize.</p>
<p>UPDATED</p> <p>UPDATED</p> <p>UPDATED</p> <p>UPDATED</p> <p>Perform These O&M Actions</p>	<ul style="list-style-type: none"> <input type="checkbox"/> No later than October 13, 2018, if you use vapor monitoring for release detection, you must demonstrate proper installation and performance through a site assessment. You must maintain a site assessment for as long as vapor monitoring is used for release detection at your facility. Site assessments completed after October 13, 2015 must be signed by a licensed professional. <input type="checkbox"/> No later than October 13, 2018, you must begin performing periodic walkthrough inspections. These inspections include checking your hand-held equipment for operability and serviceability. See Section 6 for more information about these required walkthrough inspections. <input type="checkbox"/> Use your release detection system to test for leaks at least every 30 days. Testing more often than every 30 days can identify leaks sooner and reduce cleanup costs and problems. Check all of your vapor monitoring wells. <input type="checkbox"/> If your vapor monitoring method ever fails a test or indicates a release, see Section 3 for information on what to do next. <input type="checkbox"/> No later than October 13, 2018, you must begin inspecting and testing your release detection system every year. If you use permanently installed electronic equipment for vapor monitoring, at a minimum, test the alarm, battery backup, and verify the system configuration. For probes and sensors, you must inspect for residual buildup, ensure floats move freely, ensure the shaft is not damaged, ensure accessible cables are free of kinks and breaks, and test alarm operability and communication with controller. <input type="checkbox"/> Clearly mark and secure your vapor monitoring wells. <input type="checkbox"/> Make sure employees who run, monitor, or maintain the release detection system know exactly what they have to do and to whom to report problems. No later than October 13, 2018, UST owners must have designated and trained operators. Most states already require operator training.
<p>UPDATED</p> <p>UPDATED</p> <p>UPDATED</p> <p>UPDATED</p> <p>Keep These O&M Records</p>	<ul style="list-style-type: none"> <input type="checkbox"/> Keep results of your 30-day release detection monitoring for at least one year. Your monitoring equipment may provide printouts that can be used as records. See page 25 for a sample 30 day recordkeeping form. <input type="checkbox"/> Keep results for your annual release detection system operation tests for at least three years. <input type="checkbox"/> Keep all records of calibration, maintenance, and repair of your release detection equipment for at least one year. <input type="checkbox"/> Keep any schedules of required calibration and maintenance provided by the release detection equipment manufacturer for at least five years from the date of installation. <input type="checkbox"/> Keep all performance claims supplied by the installer, vendor, or manufacturer for at least five years. <input type="checkbox"/> Keep your periodic walkthrough inspection records for at least one year. <input type="checkbox"/> If you store regulated substances containing greater than 10 percent ethanol or greater than 20 percent biodiesel or any other regulated substance identified by your implementing agency, keep records demonstrating compatibility for as long as the UST system stores the regulated substance.

Checklist For Groundwater Monitoring (For Tanks And Piping)

Groundwater Monitoring (For Tanks And Piping)	
Description	Groundwater monitoring looks for the presence of liquid product floating on groundwater at the UST site. To ensure a leak is detected, follow the site assessment plan, which determines the number and placement of monitoring wells. Note that this method cannot be used at sites where groundwater is more than 20 feet below the surface.
<p>UPDATED</p> <p>UPDATED</p> <p>Perform These O&M Actions</p> <p>UPDATED</p>	<ul style="list-style-type: none"> <input type="checkbox"/> No later than October 13, 2018, if you use groundwater monitoring for release detection, you must demonstrate proper installation and performance through a site assessment. You must maintain a site assessment for as long as groundwater monitoring is used for release detection at your facility. Site assessments completed after October 13, 2015 must be signed by a licensed professional. <input type="checkbox"/> No later than October 13, 2018, you must begin performing periodic walkthrough inspections. These inspections include checking your hand-held equipment for operability and serviceability. See Section 6 for more information about these required walkthrough inspections. <input type="checkbox"/> Use your release detection system to test for leaks at least every 30 days. Testing more often than every 30 days can identify leaks sooner and reduce cleanup costs and problems. Check all of your groundwater monitoring wells. <input type="checkbox"/> If your groundwater monitoring method ever fails a test or indicates a release, see Section 3 for information on what to do next. <input type="checkbox"/> No later than October 13, 2018, you must begin inspecting and testing your release detection system every year. If you use permanently installed electronic equipment for groundwater monitoring, at a minimum, test the alarm, battery backup, and verify the system configuration. For probes and sensors, you must inspect for residual buildup, ensure floats move freely, ensure the shaft is not damaged, ensure accessible cables are free of kinks and breaks, and test alarm operability and communication with controller. <input type="checkbox"/> Clearly mark and secure your groundwater monitoring wells. <input type="checkbox"/> Make sure employees who run, monitor, or maintain the release detection system know exactly what they have to do and to whom to report problems. No later than October 13, 2018, UST owners must have designated and trained operators. Most states already require operator training.
<p>UPDATED</p> <p>Keep These O&M Records</p> <p>UPDATED</p> <p>UPDATED</p>	<ul style="list-style-type: none"> <input type="checkbox"/> Keep results of your 30-day release detection monitoring for at least one year. Your monitoring equipment may provide printouts that can be used as records. See page 25 for a sample 30 day recordkeeping form. <input type="checkbox"/> Keep results for your annual release detection system operation tests for at least three years. <input type="checkbox"/> Keep all records of calibration, maintenance, and repair of your release detection equipment for at least one year. <input type="checkbox"/> Keep any schedules of required calibration and maintenance provided by the release detection equipment manufacturer for at least five years from the date of installation. <input type="checkbox"/> Keep all performance claims supplied by the installer, vendor, or manufacturer for at least five years. <input type="checkbox"/> Keep your periodic walkthrough inspection records for at least one year. <input type="checkbox"/> If you store regulated substances containing greater than 10 percent ethanol or greater than 20 percent biodiesel or any other regulated substance identified by your implementing agency, keep records demonstrating compatibility for as long as the UST system stores the regulated substance.

Checklist For Inventory Control And Tank Tightness Testing (For Tanks)

Inventory Control And Tank Tightness Testing (For Tanks)	
<p>UPDATED</p>	<p>Description</p> <p>This temporary method combines monthly inventory control with periodic tank tightness testing. Inventory control involves taking measurements of tank contents and recording the amount of product pumped each operating day, measuring and recording tank deliveries, and reconciling all this data at least once a month. This combined method also includes tank tightness testing, a sophisticated test performed by trained professionals.</p> <p>Please note that this combination method can only be used temporarily, for up to 10 years after your UST was installed. You may no longer use this method after April 11, 2026 because tanks and piping installed or replaced after April 11, 2016 must have secondary containment and interstitial monitoring.</p>
<p>UPDATED</p> <p>UPDATED</p>	<p>Perform These O&M Actions</p> <ul style="list-style-type: none"> <input type="checkbox"/> Take inventory readings and record the numbers at least each day that product is added to or taken out of the tank. You may use the sample daily inventory worksheet on page 18. <input type="checkbox"/> Reconcile the fuel deliveries with delivery receipts by taking inventory readings before and after each delivery. Record these readings on a daily inventory worksheet on page 18. <input type="checkbox"/> Reconcile all your data at least every 30 days. Use a monthly inventory record; see the sample on page 19. <input type="checkbox"/> Conduct a tank tightness test at least every five years. A professional trained in performing tank tightness testing must conduct this test. <input type="checkbox"/> See Section 3 if your tank fails a tightness test or fails two consecutive months of inventory control. <input type="checkbox"/> Ensure that your measuring stick can measure to the nearest one-eighth inch and can measure the level of product over the full range of the tank's height. <input type="checkbox"/> Ensure that your product dispenser is calibrated according to local standards or to an accuracy of 6 cubic inches for every 5 gallons of product withdrawn. <input type="checkbox"/> Measure the water in your tank to the nearest one-eighth inch at least once a month and record the results on the reconciliation sheet. You can use a paste that changes color when it comes into contact with water. If you find water in your tank, you must investigate and determine the reason for its presence. The presence of water in your tank is an unusual operating condition. You should remove the water as soon as possible because it can cause problems such as corrosion and degrading fuel quality. <input type="checkbox"/> No later than October 13, 2018, you must begin performing periodic walkthrough inspections. These inspections include checking your tank gauging stick for operability and serviceability. See Section 6 for more information about these required walkthrough inspections. <input type="checkbox"/> Make sure employees who run, monitor, or maintain the release detection system know exactly what they have to do and to whom to report problems. No later than October 13, 2018, UST owners must have designated and trained operators. Most states already require operator training.
<p>UPDATED</p>	<p>Keep These O&M Records</p> <ul style="list-style-type: none"> <input type="checkbox"/> Keep results of your 30-day release detection monitoring for at least one year. See the sample daily inventory worksheet and monthly inventory record on pages 18 and 19, respectively. <input type="checkbox"/> Keep the results of your most recent tightness test. <input type="checkbox"/> Keep all performance claim documentation for tank tightness tests performed at your UST site for at least five years. <input type="checkbox"/> Keep your periodic walkthrough inspection records for at least one year.

Sample Daily Inventory Worksheet

Facility Name: _____ Your Name: _____ Date: _____

Date					
Tank Identification					
Type Of Fuel					
Tank Size In Gallons					
End Stick Inches					
Amount Pumped					
Totalizer Reading					
Totalizer Reading					
Totalizer Reading					
Totalizer Reading					
Totalizer Reading					
Totalizer Reading					
Totalizer Reading					
Totalizer Reading					
Today's Sum Of Totalizers					
Previous Day's Sum Of Totalizers					
Amount Pumped Today					
Delivery Record					
Inches Of Fuel Before Delivery					
Gallons Of Fuel Before Delivery (from tank chart)					
Inches Of Fuel After Delivery					
Gallons Of Fuel After Delivery (from tank chart)					
Gallons Delivered (Stick) [Gallons After - Gallons Before]					
Gross Gallons Delivered (Receipt)					

Sample Monthly Inventory Record

Month/Year : _____ / _____

Tank Identification; Type Of Fuel: _____

Facility Name: _____

Date Of Water Check: _____ Level Of Water (Inches): _____

Date	Start Stick Inventory (Gallons)	Gallons Delivered	Gallons Pumped	Book Inventory (Gallons)	End Stick Inventory		Daily Over (+) Or Short (-) [End - Book]	Initials
					(Inches)	(Gallons)		
1	(+)	(-)	(=)					
2	(+)	(-)	(=)					
3	(+)	(-)	(=)					
4	(+)	(-)	(=)					
5	(+)	(-)	(=)					
6	(+)	(-)	(=)					
7	(+)	(-)	(=)					
8	(+)	(-)	(=)					
9	(+)	(-)	(=)					
7	(+)	(-)	(=)					
8	(+)	(-)	(=)					
9	(+)	(-)	(=)					
10	(+)	(-)	(=)					
11	(+)	(-)	(=)					
12	(+)	(-)	(=)					
13	(+)	(-)	(=)					
14	(+)	(-)	(=)					
15	(+)	(-)	(=)					
16	(+)	(-)	(=)					
17	(+)	(-)	(=)					
18	(+)	(-)	(=)					
19	(+)	(-)	(=)					
20	(+)	(-)	(=)					
21	(+)	(-)	(=)					
22	(+)	(-)	(=)					
23	(+)	(-)	(=)					
24	(+)	(-)	(=)					
25	(+)	(-)	(=)					
26	(+)	(-)	(=)					
27	(+)	(-)	(=)					
28	(+)	(-)	(=)					
29	(+)	(-)	(=)					
30	(+)	(-)	(=)					
31	(+)	(-)	(=)					

Total Gallons Pumped >

Total Gallons Over Or Short >

Leak Check:

Drop the last two digits from the Total Gallons

Pumped number and enter here: _____

+

130

=

_____ gallons

Compare these numbers

Is the **total gallons over or short** larger than **leak check** result? **Yes** **No** (circle one)

If your answer is Yes for 2 months in a row, **notify your implementing agency** as soon as possible.

Keep this record for at least one year.

Checklist For Manual Tank Gauging (For Tanks 1,000 Gallons Or Less)

Manual Tank Gauging (For Tanks 1,000 Gallons Or Less)	
<p>Description</p>	<p>Manual tank gauging involves taking your tank out of service for at least 36 hours during the test period each week. During that time, the contents of the tank are measured twice at the beginning and twice at the end of the test period. The measurements are then compared to weekly and monthly standards to determine if the tank is tight.</p> <p>This method may be used only for tanks of 1,000 gallons or less capacity meeting certain requirements. These requirements – tank size, tank dimension, and test time – are listed on page 21 in the sample manual tank gauging record.</p>
<p>Perform These O&M Actions</p>	<ul style="list-style-type: none"> <input type="checkbox"/> Once a week, record two inventory readings at the beginning of the test, allow the tank to sit undisturbed for the time specified in the sample manual tank gauging record on page 21, and record two inventory readings at the end of the test. <input type="checkbox"/> Reconcile the numbers weekly and record them on a manual tank gauging record; see page 21. <input type="checkbox"/> At the end of four weeks, reconcile your records for the monthly standard and record the result on a manual tank gauging record; see page 21. <input type="checkbox"/> See Section 3 if your tank fails the weekly standard or monthly standard. <input type="checkbox"/> Ensure that your measuring stick can measure to the nearest one-eighth inch and can measure the level of product over the full range of the tank's height. <input type="checkbox"/> No later than October 13, 2018, you must begin performing periodic walkthrough inspections. These inspections include checking your tank gauging stick for operability and serviceability. See Section 6 for more information about these required walkthrough inspections. <input type="checkbox"/> Make sure employees who run, monitor, or maintain the release detection system know exactly what they have to do and to whom to report problems. No later than October 13, 2018, UST owners must have designated and trained operators. Most states already require operator training.
<p>Keep These O&M Records</p>	<ul style="list-style-type: none"> <input type="checkbox"/> Keep results of your 30-day release detection monitoring for at least one year. See the sample manual tank gauging record on page 21. <input type="checkbox"/> Keep your periodic walkthrough inspection records for at least one year.

UPDATED

UPDATED

UPDATED

Sample Manual Tank Gauging Record

Month: _____ Year _____
 Tank Identification: _____
 Person Completing Form: _____
 Facility Name: _____

Tank Size	Minimum Duration Of Test	Weekly Standard (1 test)	Monthly Standard (4-test average)
Up to 550 gallons	36 hours	10 gallons	5 gallons
551-1,000 gallons (when tank diameter is 64")	44 hours	9 gallons	4 gallons
551-1,000 gallons (when tank diameter is 46")	58 hours	12 gallons	6 gallons
551-1,000 gallons (also requires periodic tank tightness testing)	36 hours	13 gallons	7 gallons
1,001-2,000 gallons (also requires periodic tank tightness testing)	36 hours	26 gallons	13 gallons

Compare your weekly readings and the monthly average of the 4 weekly readings with the standards shown in the table on the left.

If the calculated change exceeds the weekly standard, the UST may be leaking. Also, the monthly average of the 4 weekly test results must be compared to the monthly standard in the same way.

If either the weekly or the monthly standards have been exceeded, the UST may be leaking. As soon as possible, call your implementing agency to report the suspected leak and get further instructions.

Start Test (month, day, and time)	First Initial Stick Reading	Second Initial Stick Reading	Average Initial Reading	Initial Gallons (convert inches to gallons [a])	End Test (month, day, and time)	First End Stick Reading	Second End Stick Reading	Average End Reading	End Gallons (convert inches to gallons [b])	Change In Tank Volume In Gallons + or (-) [a - b]	Tank Passes Test (circle Y or N)
Date: _____ Time: _____ AM/PM					Date: _____ Time: _____ AM/PM						Y N
Date: _____ Time: _____ AM/PM					Date: _____ Time: _____ AM/PM						Y N
Date: _____ Time: _____ AM/PM					Date: _____ Time: _____ AM/PM						Y N
Date: _____ Time: _____ AM/PM					Date: _____ Time: _____ AM/PM						Y N
<p>Keep this record for at least one year.</p>											Y N
<p>To see how close you are to the monthly standard, divide the sum of the 4 weekly readings by 4 and enter result here</p>											Y N

Checklist For Manual Tank Gauging And Tank Tightness Testing (For Tanks 2,000 Gallons Or Less)

Manual Tank Gauging And Tank Tightness Testing (For Tanks 2,000 Gallons Or Less)	
Description	<p>This method combines manual tank gauging with periodic tank tightness testing. It may be used only for tanks of 2,000 gallons or less capacity. Manual tank gauging involves taking your tank out of service for at least 36 hours during the test period each week. During that time, the contents of the tank are measured twice at the beginning and twice at the end of the test period. The measurements are then compared to weekly and monthly standards to determine if the tank is tight. This combined method also includes tank tightness testing, a sophisticated test performed by trained professionals.</p> <p>Please note that this combination method can only be used temporarily, for up to 10 years after your UST was installed. You may no longer use this method after April 11, 2026 because tanks and piping installed or replaced after April 11, 2016 must have secondary containment and interstitial monitoring.</p>
Perform These O&M Actions	<ul style="list-style-type: none"> <input type="checkbox"/> Once a week, record two inventory readings at the beginning of the test, allow the tank to sit undisturbed for the time specified in the sample manual tank gauging record on page 21, and record two inventory readings at the end of the test. <input type="checkbox"/> Reconcile the numbers weekly and record them on a manual tank gauging record; see page 21. <input type="checkbox"/> At the end of four weeks, reconcile your records for the monthly standard and record the result on a manual tank gauging record; see page 21. <input type="checkbox"/> Conduct a tank tightness test at least every five years. This testing needs to be conducted by a professional trained in performing tank tightness testing. <input type="checkbox"/> See Section 3 if your tank fails the tightness test, weekly standard, or monthly standard. <input type="checkbox"/> Ensure that your measuring stick can measure to the nearest one-eighth inch and can measure the level of product over the full range of the tank's height. <input type="checkbox"/> No later than October 13, 2018, you must begin performing periodic walkthrough inspections. These inspections include checking your tank gauging stick for operability and serviceability. See Section 6 for more information about these required walkthrough inspections. <input type="checkbox"/> Make sure employees who run, monitor, or maintain the release detection system know exactly what they have to do and to whom to report problems. No later than October 13, 2018, UST owners must have designated and trained operators. Most states already require operator training.
Keep These O&M Records	<ul style="list-style-type: none"> <input type="checkbox"/> Keep results of your 30-day release detection monitoring for at least one year. See the sample manual tank gauging record on page 21. <input type="checkbox"/> Keep your periodic walkthrough inspection records for at least one year.

UPDATED

UPDATED

UPDATED

UPDATED

Checklist For Automatic Line Leak Detection (For Pressurized Piping)

Automatic Line Leak Detection (For Pressurized Piping)	
<p>Description</p>	<p>Automatic line leak detectors (LLDs) are designed to detect a catastrophic leak from pressurized piping. Automatic LLDs must be designed to detect a leak at least as small as 3 gallons per hour at a line pressure of 10 pounds per square inch within one hour. When a leak is detected, automatic LLDs must shut off the product flow, restrict the product flow, or trigger an audible or visual alarm. Please note that mechanical LLDs need to be installed and operated as close as possible to the tank. LLDs are designed to detect a leak, restrict flow, or trigger an alarm only between the detector and the dispenser.</p>
<p>UPDATED</p> <p>Perform These O&M Actions</p>	<ul style="list-style-type: none"> <input type="checkbox"/> No later than October 13, 2018, you must begin inspecting and testing your release detection system, including LLDs, every year. You must test your LLDs by simulating a leak, which evaluates the LLDs' ability to detect a leak. <input type="checkbox"/> See Section 3 if your LLDs detect a release. <input type="checkbox"/> Make sure employees who run, monitor, or maintain the release detection system know exactly what they have to do and to whom to report problems. No later than October 13, 2018, UST owners must have designated and trained operators. Most states already require operator training.
<p>UPDATED</p> <p>UPDATED</p> <p>Keep These O&M Records</p> <p>UPDATED</p>	<ul style="list-style-type: none"> <input type="checkbox"/> Keep results for your annual release detection system operation tests for at least three years. <input type="checkbox"/> Keep all records of calibration, maintenance, and repair of your release detection equipment for at least one year. <input type="checkbox"/> Keep any schedules of required calibration and maintenance provided by the release detection equipment manufacturer for at least five years from the date of installation. <input type="checkbox"/> Keep all performance claims supplied by the installer, vendor, or manufacturer for at least five years. <input type="checkbox"/> If you store regulated substances containing greater than 10 percent ethanol or greater than 20 percent biodiesel or any other regulated substance identified by your state UST agency, keep records demonstrating compatibility for as long as the UST system stores the regulated substance.

Checklist For Line Tightness Testing (For Piping)

Line Tightness Testing (For Piping)	
Description	<p>This method uses a periodic line tightness test to determine if your piping is leaking. Tightness testing can be performed by either a trained professional or by using a permanently installed electronic system, which is sometimes connected to an automatic tank gauging system.</p>
<p>Perform These O&M Actions</p>	<ul style="list-style-type: none"> <input type="checkbox"/> If you have pressurized piping and use line tightness testing, you must conduct the test at least annually. <input type="checkbox"/> If you have suction piping and use line tightness testing, you must conduct the test at least every three years. Safe suction piping, as described at the bottom of page 5, does not need release detection. <input type="checkbox"/> You must have this tightness testing conducted by a professional trained in performing line tightness testing or use a permanently installed electronic system. <input type="checkbox"/> See Section 3 if your piping fails the tightness test or if the electronic system indicates a release. <input type="checkbox"/> No later than October 13, 2018, you must begin inspecting and testing your release detection system, including LLDs, every year. You must test your LLDs by simulating a leak, which evaluates the LLDs' ability to detect a leak. <input type="checkbox"/> Make sure employees who run, monitor, or maintain the release detection system know exactly what they have to do and to whom to report problems. No later than October 13, 2018, UST owners must have designated and trained operators. Most states already require operator training.
<p>Keep These O&M Records</p>	<ul style="list-style-type: none"> <input type="checkbox"/> Keep results of your most recent line tightness test. Keep any results for your electronic release detection equipment operation and maintenance tests for at least three years. Your monitoring equipment may provide printouts, which can be used as records. <input type="checkbox"/> If using an electronic line leak detector for tightness testing, keep results for your annual release detection system operation tests for at least three years. <input type="checkbox"/> Keep all records of calibration, maintenance, and repair of your release detection equipment for at least one year. <input type="checkbox"/> Keep any schedules of required calibration and maintenance provided by the release detection equipment manufacturer for at least five years from the date of installation. <input type="checkbox"/> Keep all performance claims supplied by the installer, vendor, or manufacturer for at least five years. <input type="checkbox"/> If you store regulated substances containing greater than 10 percent ethanol or greater than 20 percent biodiesel or any other regulated substance identified by your implementing agency, keep records demonstrating compatibility for as long as the UST system stores the regulated substance.

UPDATED

UPDATED

UPDATED

UPDATED

Section 3: Suspected Or Confirmed Releases



You must be fully prepared to respond to releases before they occur. You must know what to do when release detection methods indicate a suspected or confirmed release. Be ready to take the following steps, as appropriate, if you have a release.

Stop The Release

- Take immediate action to prevent the release of more product.
- Use the emergency shutoff switch to stop the flow of product. (Make sure you know where your emergency shutoff switch is located.)
- Turn off the power to the dispenser and place a bag over the nozzle.
- Identify any fire, explosion, or vapor hazards and take action to neutralize these hazards.
- Empty the tank, if necessary, without further contaminating the site. You may need the assistance of your supplier or distributor.

Call For Help

- Contact your local fire or emergency response authority. Make sure you have these crucial telephone numbers prominently posted where you and your employees can easily see them.

Contain The Release

Contain, absorb, and clean up any surface spills or overfills. You should keep enough absorbent material at your facility to contain a spill or overfill of petroleum products until emergency response personnel can respond to the incident. The suggested supplies include, but are not limited to:

- Containment devices, such as containment booms, dikes, and pillows.

Page 29 is a blank form to list names and phone numbers of important contacts. Fill out this information for your facility so that you will know who to call in case of an emergency. Print this page from the booklet, fill it out, and post it in a prominent place at your facility.

Print multiple copies of page 29 and update it often. Make sure everyone at your UST facility is familiar with this list of contacts.

- Absorbent material, such as kitty litter, chopped corn cob, sand, and sawdust. Be sure you properly dispose of used absorbent materials.
- Mats or other material capable of keeping spill or overflow out of nearby storm drains.
- Spark-free flash light.
- Spark-free shovel.
- Buckets.
- Reels of caution tape, traffic cones, and warning signs.
- Personal protective gear.

Report To Authorities

If you observe any of the following, contact your implementing agency to report a suspected or confirmed release as soon as possible or within 24 hours:

- Any spill or overflow of petroleum that exceeds 25 gallons or causes a sheen on nearby surface water. Spills and overfills under 25 gallons that are contained and immediately cleaned up do not have to be reported. If they cannot be quickly cleaned up, you must report them to your implementing agency.
- Any released regulated substances at the UST site or in the surrounding area — such as the presence of liquid petroleum; soil contamination; surface water or groundwater contamination; or petroleum vapors in sewer, basement, or utility lines.
- Any unusual operating conditions you observe — such as erratic behavior of the dispenser, a sudden loss of product, unexplained presence of water in the tank, or liquid in the interstitial space of secondarily-contained systems.

However, you are not required to report if:

- The system equipment is found to be defective, but did not have a release, and is immediately repaired or replaced.
- For secondarily-contained systems, any liquid in the interstitial space not used as part of the interstitial monitoring method is immediately removed (for example, fuel in the interstitial space of a monitoring system intended to be operated with brine).
- Results from your release detection system, including investigation of an alarm, indicate a suspected release. However, you are not required to report if:
 - The monitoring device is found to be defective and is immediately repaired, recalibrated, or replaced and further monitoring does not confirm the initial suspected release; or

- The leak is contained in the secondary containment and any liquid in the interstitial space not used as part of the interstitial monitoring method is immediately removed and any defective system equipment or component is immediately repaired or replaced; or
- In the case of inventory control, a second month of data does not confirm the initial result or the investigation determines no release has occurred; or
- The alarm was investigated and determined to be a non-release event; for example, from a power surge or caused by filling the tank during release detection testing.

Release Response

Important Contact Information

	Contact Name	Phone #
Implementing UST Agency:	_____	_____
Local UST Agency:	_____	_____
Fire Department:	_____	_____
Ambulance:	_____	_____
Police Department:	_____	_____
Repair Contractor:	_____	_____
Other Contacts:	_____	_____
_____	_____	_____
_____	_____	_____
_____	_____	_____
_____	_____	_____
_____	_____	_____

Release Response Checklist

- Stop the release: Take immediate action to prevent the release of more product. Use the emergency shutoff switch to stop the flow of product. Turn off the power to the dispenser and place a bag over the nozzle. Empty the tank, if necessary, without further contaminating the site.
- Contain the release: Contain, absorb, and clean up any surface releases. Identify any fire, explosion, or vapor hazards and take action to neutralize these hazards.
- Call for help and to report suspected or confirmed releases: Contact your local fire or emergency response authority. Contact your implementing agency within 24 hours.

Section 4: Spill And Overfill Protection



The purpose of spill and overfill protection equipment is to reduce the potential for a release during fuel deliveries. The equipment must be in working order and used properly to provide adequate protection from spills and overfills.

Even the best spill and overfill protection equipment can become faulty over time if not properly operated and maintained. Small fuel leaks from a poorly maintained spill bucket can result in large amounts of contaminated soil over time. And improperly operating overfill prevention equipment can result in tank overfills.

UPDATED

The 2015 federal UST regulation requires operability testing of spill buckets and inspections of overfill prevention equipment once every three years. The test must be conducted according to a code of practice, manufacturer's instructions, or requirements developed by the implementing agency. In addition, it requires walkthrough inspections that look at spill equipment at least every 30 days. Records of walkthrough inspections must be kept and must include a list of each area checked, whether each area checked was acceptable or needed action, and a description of actions taken to correct an issue. If owners and operators receive deliveries less frequently than every 30 days, spill prevention equipment may be checked prior to each delivery. Delivery records must be maintained if spill prevention equipment is checked less frequently than every 30 days.

UPDATED

If you repair your spill or overfill prevention equipment, you must test or inspect, as appropriate, the equipment within 30 days after the repair.

The following pages focus on how you can routinely make sure your spill and overfill equipment are operating effectively.

What Is The Difference?

Spill Protection

A spill bucket is installed at the fill pipe to contain the drips and spills of fuel that can occur when the delivery hose is uncoupled from the fill pipe after delivery.

Overfill Protection

Equipment is installed on the UST and designed to stop product flow, reduce product flow, or alert the delivery person during delivery that the tank is nearing full capacity. This allows the person filling the tank to stop product delivery before the tank becomes full and begins releasing product into the environment.

What Are The Basics Of Spill Protection?

Your USTs must have spill buckets — also called catchment basins — installed at the fill pipe to contain small-volume spills that may occur as a result of fuel deliveries.

- Spill buckets are designed to temporarily contain product spills that might occur during fuel delivery. To contain a spill, the spill bucket must be liquid tight.
- Spill buckets are not designed to contain fuel for long periods. After each delivery, empty and dispose of contents properly.
- Spill buckets need to be large enough to contain any fuel that may spill when the delivery hose is uncoupled from the fill pipe. Spill buckets typically range in size from 5 gallons to 15 gallons.
- If you use correct delivery practices such as the ones described on page 41, spills should be eliminated or reduced to very small volumes that your spill bucket can easily handle.

The checklist on the next page provides information on properly maintaining your spill bucket.

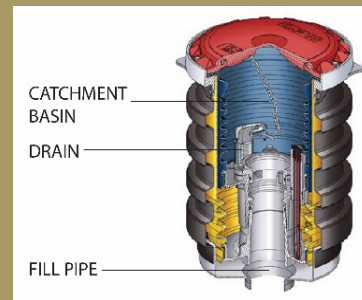

Spill bucket

Your equipment supplier can help you choose the size and type of spill bucket that meets your needs.

If your UST only receives deliveries of 25 gallons or less at a time, the UST does not need to meet the spill and overfill protection requirements. Many used oil tanks fall into this category. Even though these USTs are not required to have spill and overfill protection, you should consider using spill and overfill protection as part of good UST system management.

Checklist For Spill Buckets

Spill Buckets	
Description	Spill buckets are basins installed at the fill pipe to temporarily contain product spills that may occur during fuel delivery.
Perform These O&M Actions	<ul style="list-style-type: none"> <input type="checkbox"/> No later than October 13, 2018, you must conduct your first 30 day walkthrough inspection. Note that if you receive deliveries less frequently than every 30 days, you may check your spill bucket before each delivery. <ul style="list-style-type: none"> <input type="checkbox"/> Visually check for any damage to the spill bucket. <input type="checkbox"/> Remove any liquid or debris from the spill bucket. <input type="checkbox"/> Check for and remove any obstructions, such as tank gauging sticks, in the fill pipe. <input type="checkbox"/> Make sure your fill cap is securely fastened. <input type="checkbox"/> If you have a double-walled spill bucket with interstitial monitoring, check your interstitial monitoring device for a leak into the interstitial area. <input type="checkbox"/> No later than October 13, 2018, you must conduct the first 3 year test of your spill bucket. This test should be conducted by a person qualified to conduct spill bucket testing. If you use a double-walled spill bucket and check the interstitial space of your spill bucket for leaks during the walkthrough inspection, then this testing is not required.
Keep These O&M Records	<ul style="list-style-type: none"> <input type="checkbox"/> Keep records of your spill bucket testing for three years or keep documentation showing the spill bucket is double-walled and the integrity of both walls is periodically monitored for as long as spill bucket testing is not performed. See a sample recordkeeping form for this test on page 33. <input type="checkbox"/> Keep records of your periodic walkthrough inspections for one year. <input type="checkbox"/> Keep delivery records for one year if you conduct walkthrough inspections of your spill bucket less frequently than every 30 days. <input type="checkbox"/> If you store regulated substances containing greater than 10 percent ethanol or greater than 20 percent biodiesel (or any other regulated substance identified by your implementing agency), you must keep records demonstrating compatibility of all UST system components in contact with the regulated substance, including spill buckets, for as long as the UST system stores the regulated substance.

UPDATED

UPDATED

UPDATED

UPDATED

UPDATED

UPDATED

Sample Recordkeeping Form For Liquid Tightness Tests For Spill Buckets And Containment Sumps (For Use By A Qualified Tester)

Test Date: ____/____/____ Facility Name/ID: _____

Tank number					
Product stored					
Spill bucket/containment sump ID					
Spill bucket/containment sump manufacturer					
Liquid or debris removed from bucket/sump?* (circle one)	Yes / No	Yes / No	Yes / No	Yes / No	Yes / No
Visual inspection (no cracks, loose parts, or separation) (circle one)	Pass / Fail	Pass / Fail	Pass / Fail	Pass / Fail	Pass / Fail
Starting water or vacuum level					
Test start time					
Ending water or vacuum level					
Test end time					
Test duration					
Water or vacuum level change					
Test results (circle one)**	Pass / Fail	Pass / Fail	Pass / Fail	Pass / Fail	Pass / Fail
Comments					

* All liquids and debris must be disposed of properly.

** Pass or fail criteria are based on the method used for testing. For example, EPA allows the Petroleum Equipment Institute's Recommended Practice 1200 to be used for this testing. This code of practice contains information about the pass or fail criteria.

Notes:

Testing company: _____

Tester's name: _____

Tester's signature: _____

Keep this record for three years.

What Are The Basics Of Overfill Protection?

Your USTs must have overfill protection installed to help prevent overfilling of tanks.

Three types of overfill protection devices are commonly used:

- Automatic shutoff devices
- Overfill alarms
- Ball float valves, also referred to as flow restrictors or float vent valves

These forms of overfill protection are discussed in detail on the following pages.

UPDATED

Note that ball float valves may not be installed or replaced for use as overfill protection after October 13, 2015.

How Can You Help The Delivery Person Avoid Overfills?

To protect your business, you must make every effort to help the delivery person avoid overfilling your UST.

- Use correct filling practices. If correct filling practices are used, you will not exceed the UST's capacity — see page 41 for a checklist of correct filling practices. Overfills can result when the delivery person makes a mistake, such as ignoring an overfill alarm.
- Use signs; alert your delivery person. The delivery person should know what type of overfill device is present on each tank at your facility and what action will occur if the overfill device is triggered — such as a visual or audible alarm or that the product flow into the tank will stop or slow significantly. Educate and alert your delivery person by placing a sign near your fill pipes, in plain view of the delivery person. See the example below.

Delivery Person – Avoid Overfills

- An overfill alarm is used for overfill protection at this facility.
- Do not tamper with this alarm or attempt to defeat its purpose.
- When the tank is 90% full, the overfill alarm whistles and a red light flashes.
- If you hear the alarm whistle or see the red light flashing, **stop the delivery immediately.**

- Make sure you order the right amount of product. Order only the quantity of fuel that will fit into 90 percent of the tank. For example, if you have a 10,000 gallon tank with 2,000 gallons already in the tank, you would order at most a 7,000 gallon delivery (90 percent of 10,000 is 9,000 gallons; subtracting the 2,000 gallons already in the tank leaves a maximum delivery of 7,000 gallons). Use the formula on page 41. Calculate carefully and reduce the chance of overfills.

What Should You Do To Operate And Maintain Your Automatic Shutoff Device?

The automatic shutoff device is a mechanical device installed in line with the drop tube in the fill pipe riser. It slows down and stops delivery when product reaches a certain level in the tank. It must be positioned so that the float arm is unobstructed and can move through its full range of motion.

When installed and maintained properly, the shutoff valve will shut off the flow of fuel to the UST at 95 percent of the tank's capacity or before the fittings at the top of the tank are exposed to fuel.

The checklist on the next page provides information on properly maintaining your automatic shutoff device.

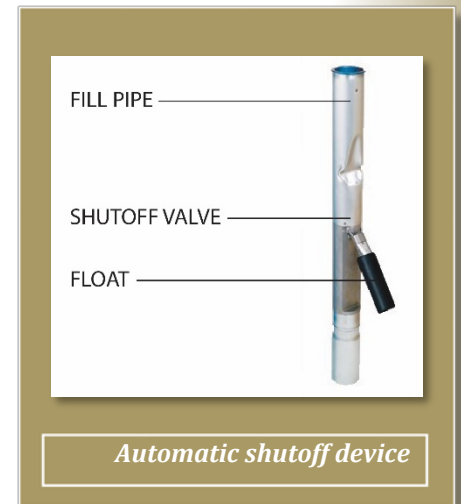

Automatic shutoff device

You should not use an automatic shutoff device for overfill protection if your UST receives pressurized deliveries.

Checklist For Automatic Shutoff Devices

Automatic Shutoff Devices	
Description	Automatic shutoff devices are mechanical devices installed in the fill pipe riser to slow down and stop delivery when product reaches a certain level in the tank.
Perform These O&M Actions	<ul style="list-style-type: none"> <input type="checkbox"/> No later than October 13, 2018, you must conduct the first 3 year inspection of your overfill device. This inspection should be conducted by a person qualified to conduct overfill inspections. The purpose of the inspection is to make sure the automatic shutoff device is functioning properly and the device will shut off fuel flowing into the tank at 95 percent of the tank capacity or before the fittings at the top of the tank are exposed to fuel. See page 42 for a sample recordkeeping form for overfill equipment inspections. <ul style="list-style-type: none"> ○ Make sure the float operates properly. ○ Make sure there are no obstructions in the fill pipe that would keep the floating mechanism from working. <input type="checkbox"/> You should post signs that the delivery person can easily see and that alert the delivery person to the overfill warning devices and alarms in use at your facility.
Keep These O&M Records	<ul style="list-style-type: none"> <input type="checkbox"/> You must maintain all records of the inspection for three years. <input type="checkbox"/> If you store regulated substances containing greater than 10 percent ethanol or greater than 20 percent biodiesel (or any other regulated substance identified by your implementing agency), you must keep records demonstrating compatibility of all UST system components in contact with the regulated substance, including overfill prevention equipment, for as long as the UST system stores the regulated substance.

UPDATED

UPDATED

UPDATED

What Should You Do To Operate And Maintain Your Electronic Overfill Alarm?

This type of overfill device activates an audible or visual warning to delivery personnel when the tank is either 90 percent full or is within one minute of being overfilled. The alarm must be located so it can be seen or heard from the UST delivery location. Once the electronic overfill alarm sounds, the delivery person has approximately one minute to stop the flow of fuel to the tank.

Electronic overfill alarm devices have no mechanism to shut off or restrict flow. Therefore, the fuel remaining in the delivery hose after the delivery has been stopped will flow into the tank as long as the tank is not yet full.

The checklist on the next page provides information on properly maintaining your overfill alarm.

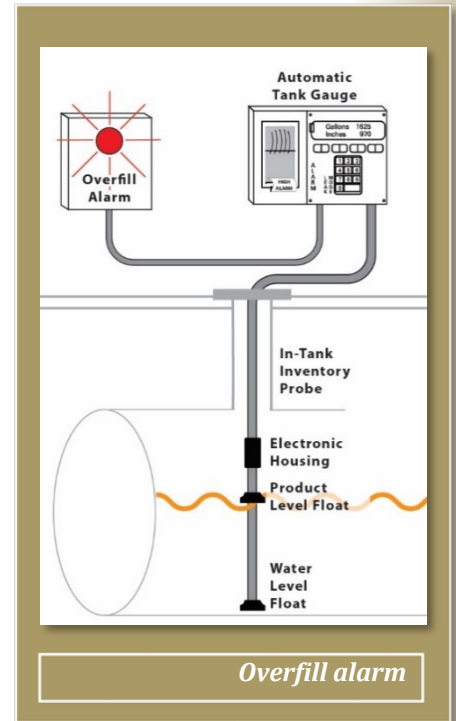

Checklist For Overfill Alarms

Overfill Alarms	
Description	Overfill alarms activate an audible or visual warning to delivery personnel when the tank is either 90 percent full or is within one minute of being overfilled. Electronic overfill alarm devices have no mechanism to shut off or restrict flow.
Perform These O&M Actions	<ul style="list-style-type: none"> <input type="checkbox"/> No later than October 13, 2018, you must conduct the first 3 year inspection of your overfill device. This inspection should be conducted by a person qualified to conduct overfill inspections. The purpose of the inspection is to make sure the electronic overfill alarm is functioning properly and the alarm activates when the fuel reaches 90 percent of the tank capacity or is within one minute of being overfilled. See page 42 for a sample recordkeeping form for overfill equipment inspections. <ul style="list-style-type: none"> <input type="checkbox"/> Ensure that the alarm can be heard or seen from where the tank is fueled. <input type="checkbox"/> Make sure that the electronic device and probe are operating properly. <input type="checkbox"/> You should post signs that the delivery person can easily see and that alert the delivery person to the overfill warning devices and alarms in use at your facility.
Keep These O&M Records	<ul style="list-style-type: none"> <input type="checkbox"/> You must maintain records of the inspection for three years. <input type="checkbox"/> If you store regulated substances containing greater than 10 percent ethanol or greater than 20 percent biodiesel (or any other regulated substance identified by your implementing agency), you must keep records demonstrating compatibility of all UST system components in contact with the regulated substance, including overfill prevention equipment, for as long as the UST system stores the regulated substance.

UPDATED

UPDATED

UPDATED

What Should You Do To Operate And Maintain Your Ball Float Valve?

UPDATED

Ball float valves cannot be installed or replaced for use as overfill protection after October 13, 2015. However, you may continue using ball float valves already installed as long as they operate properly.

The ball float valve — also called a flow restrictor or a float vent valve — is installed at the vent pipe in the tank and restricts vapor flow in an UST as the tank gets close to being full. The ball float valve must be set at a depth that will restrict vapor flow out of the vent line during delivery at 90 percent of the UST's capacity or 30 minutes prior to overfilling.

As the tank fills, the ball in the valve rises, restricting the flow of vapors out of the UST during delivery. The flow rate of the delivery will decrease noticeably and should alert the delivery person to stop the delivery.

For ball float valves to work properly, the top of the tank must be airtight so that vapors cannot escape from the tank. Everything from fittings to drain mechanisms on spill buckets must be tight and able to hold the pressure created when the ball float valve engages.

The checklist on the next page provides information on properly maintaining your ball float valves.



You should not use a ball float valve for overfill protection if your UST receives pressured deliveries or if your UST system has suction piping or single point (coaxial) stage 1 vapor recovery.

Checklist For Ball Float Valves

Ball Float Valves	
Description	Ball float valves are a type of overfill protection device that function by restricting vapor flow in an UST as the tank gets close to being full.
<div data-bbox="24 289 165 352" style="background-color: orange; color: white; padding: 2px; font-weight: bold;">UPDATED</div> Perform These O&M Actions	<input type="checkbox"/> No later than October 13, 2018, you must conduct the first 3 year inspection of your overfill device. This inspection should be conducted by a person qualified to conduct overfill inspections. The purpose of the inspection is to make sure the ball float valve is functioning properly and will restrict fuel flowing into the tank at 90 percent of the tank capacity or 30 minutes prior to overfilling. See page 42 for a sample recordkeeping form for overfill equipment inspections. <ul style="list-style-type: none"> <input type="checkbox"/> Ensure the air hole is not plugged. <input type="checkbox"/> Make sure the ball cage is still intact. <input type="checkbox"/> Ensure the ball still moves freely in the cage. <input type="checkbox"/> Make sure the ball still seals tightly on the pipe. <input type="checkbox"/> You should post signs that the delivery person can easily see and that alert the delivery person to the overfill warning devices and alarms in use at your facility.
<div data-bbox="24 659 165 722" style="background-color: orange; color: white; padding: 2px; font-weight: bold;">UPDATED</div> <div data-bbox="24 743 165 806" style="background-color: orange; color: white; padding: 2px; font-weight: bold;">UPDATED</div> Keep These O&M Records	<input type="checkbox"/> You must maintain records of the inspection for three years. <input type="checkbox"/> If you store regulated substances containing greater than 10 percent ethanol or greater than 20 percent iodiesel (or any other regulated substance identified by your implementing agency), you must keep records demonstrating compatibility of all UST system components in contact with the regulated substance, including overfill prevention equipment, for as long as the UST system stores the regulated substance.

What Are Your Responsibilities For Correct Filling Practices?

As an owner or operator, you are responsible for ensuring that releases due to spilling or overfilling do not occur during fuel delivery. As part of this responsibility, you must:

- Ensure the amount of fuel to be delivered will fit into the available empty space in the tank; and
- Ensure the transfer operation is monitored constantly to prevent overfilling and spilling.

Correct Filling Practices Checklist	
What To Do Before Your USTs Are Filled	<ul style="list-style-type: none"> <input type="checkbox"/> Post clear signs that alert the delivery person to the overfill devices and alarms in use at your facility. <input type="checkbox"/> Make and record accurate readings for product and water in the tank before fuel delivery. <input type="checkbox"/> Order only the quantity of fuel that will fit into 90 percent of the tank. <input type="checkbox"/> Remember, the formula for determining the maximum amount of gasoline to order is: <ul style="list-style-type: none"> (Tank capacity in gallons X 90%) – Product currently in tank = Maximum amount of fuel to order ○ Example: (10,000 gal X 0.9) – 2,000 gal = 7,000 gal maximum amount to order <input type="checkbox"/> Ensure the delivery person knows the type of overfill device present at the tank and what actions to perform if it activates. <input type="checkbox"/> Review and understand the spill response procedures. <input type="checkbox"/> Verify that your spill bucket is empty, clean, and will contain spills.
What To Do While Your USTs Are Being Filled	<ul style="list-style-type: none"> <input type="checkbox"/> Keep fill ports locked until the delivery person requests access. <input type="checkbox"/> Keep an accurate tank capacity chart available for the delivery person. <input type="checkbox"/> The delivery person makes all hook-ups. <input type="checkbox"/> The person responsible for monitoring the delivery should remain attentive and observe the entire fuel delivery; be prepared to stop the flow of fuel from the truck to the UST at any time; and respond to any unusual condition, leak, or spill that may occur during delivery. <input type="checkbox"/> Keep response supplies readily available for use in case a spill or overfill occurs; see section 3. <input type="checkbox"/> Provide safety barriers around the fueling zone. <input type="checkbox"/> Make sure there is adequate lighting around the fueling zone.
What To Do After Your USTs Are Filled	<ul style="list-style-type: none"> <input type="checkbox"/> Following complete delivery, the delivery person is responsible for disconnecting all hook-ups. <input type="checkbox"/> Return spill response kit and safety barriers to proper storage locations. <input type="checkbox"/> Make and record accurate readings for product and water in the tank after fuel delivery. <input type="checkbox"/> Verify the amount of fuel received. <input type="checkbox"/> Make sure fill ports are properly secured. <input type="checkbox"/> Ensure the spill bucket is free of product and clean up any small spills.

Sample Recordkeeping Form For Overfill Equipment Inspections (For Use By A Qualified Inspector)

Inspection Date: ____/____/____

Facility Name/ID: _____

Tank number					
Product stored					
Overfill equipment manufacturer					
Type (circle one)	Automatic shutoff device Ball float valve Overfill alarm	Automatic shutoff device Ball float valve Overfill alarm	Automatic shutoff device Ball float valve Overfill alarm	Automatic shutoff device Ball float valve Overfill alarm	Automatic shutoff device Ball float valve Overfill alarm
Automatic Shutoff Device Inspection					
Drop tube removed from tank?	Yes / No	Yes / No	Yes / No	Yes / No	Yes / No
Drop tube and float mechanisms are free of debris?	Yes / No	Yes / No	Yes / No	Yes / No	Yes / No
Float moves freely without binding and poppet moves into flow path?	Yes / No	Yes / No	Yes / No	Yes / No	Yes / No
Bypass valve in the drop tube (if present) is open and free of blockage?	Yes / No	Yes / No	Yes / No	Yes / No	Yes / No
Flapper is adjusted to shut off flow at 95% capacity?	Yes / No	Yes / No	Yes / No	Yes / No	Yes / No
Overfill Alarm Inspection					
Electronic device and probe are operating properly?	Yes / No	Yes / No	Yes / No	Yes / No	Yes / No
Alarm activates at 90% capacity or within one minute of overfill?	Yes / No	Yes / No	Yes / No	Yes / No	Yes / No
Alarm can be heard or seen from where the tank is fueled?	Yes / No	Yes / No	Yes / No	Yes / No	Yes / No
Ball Float Valve Inspection					
Tank top fittings are vapor-tight and leak-free?	Yes / No	Yes / No	Yes / No	Yes / No	Yes / No
Ball float cage free of debris?	Yes / No	Yes / No	Yes / No	Yes / No	Yes / No
Ball is free of holes and cracks and moves freely in cage?	Yes / No	Yes / No	Yes / No	Yes / No	Yes / No
Vent hole in pipe is open and near top of tank?	Yes / No	Yes / No	Yes / No	Yes / No	Yes / No
Ball float pipe is proper length to restrict flow at 90% capacity?	Yes / No	Yes / No	Yes / No	Yes / No	Yes / No
Inspection Results (Circle One) (No to any question indicates a test failure.)	Pass / Fail	Pass / Fail	Pass / Fail	Pass / Fail	Pass / Fail
Comments					

Inspecting company: _____

Inspector's signature: _____

Inspector's name: _____

Keep this record for three years.

Section 5: Corrosion Protection



To prevent leaks, all parts of your UST system that are in contact with the ground and routinely contain product must be protected from corrosion. The UST system includes the tank, piping, and ancillary equipment, such as flexible connectors, fittings, and pumps. Unprotected metal UST components can deteriorate and leak when underground electrical currents act upon them.

One way to protect UST components from corrosion is to make them with nonmetallic, noncorrodible materials, such as USTs made of or clad or jacketed with fiberglass reinforced plastic or other noncorrodible materials. Noncorrodible USTs like these do not require O&M for corrosion protection.

UST components made from metal that are not clad or jacketed with a noncorrodible material, and that routinely contain product and are in direct contact with the ground, must have corrosion protection, typically cathodic protection. In some cases, the interior of the tank may be lined. These options require O&M.

Cathodic protection using sacrificial anode systems – sacrificial anodes are buried and attached to UST components for corrosion protection by an anode attached to a tank. Anodes are pieces of metal that are more electrically active than steel, and thus they suffer the destructive effects of corrosion rather than the steel they are attached to.

Cathodic protection using impressed current systems – an impressed current system uses a rectifier to provide direct current through anodes to the tank or piping to achieve corrosion protection. The steel is protected because the current going to the steel overcomes the corrosion-causing current flowing away from it. The cathodic protection rectifier must always be

Corrosion results when bare metal and soil and moisture conditions combine to produce an underground electric current that destroys hard metal. Over time, unprotected USTs can corrode and leak.

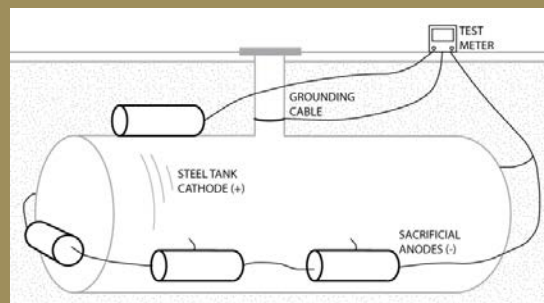

Sacrificial anode system

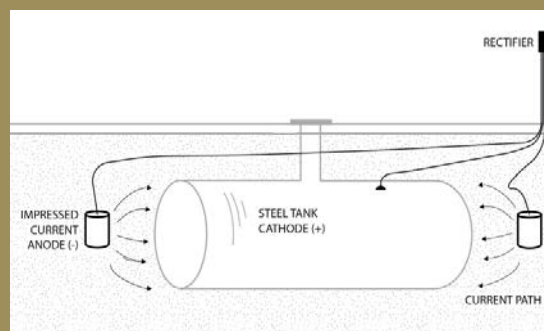

Impressed current system

on and operating to protect your UST system from corrosion.

Corrosion protection using internal lining of the tank – this corrosion protection option applies only to tanks installed before December 22, 1988. These older tanks were internally lined by trained professionals to meet the corrosion protection requirements. Note that internal lining may still be used in tanks for purposes other than corrosion protection.

In addition to tanks and piping, all other metal components in direct contact with the ground that routinely hold product — such as flexible connectors, swing joints, fittings, and pumps — must also be protected from corrosion.

In the 2015 federal UST regulation, EPA revised the internal lining requirement. **Owners and operators must permanently close tanks using internal lining as the sole method of corrosion protection, if the internal lining fails the periodic inspection and cannot be repaired according to a code of practice.**

UPDATED

The table below contains your corrosion protection options.

Corrosion Protection Option	Description
Noncorrodible Material	The tank or piping is constructed of noncorrodible material.
Steel Tank Clad Or Jacketed With A Noncorrodible Material	Examples of cladding or jacket material include fiberglass and urethane. Does not apply to piping.
Coated And Cathodically Protected Steel Tanks Or Piping	Steel tank and piping are well coated with a dielectric material and cathodically protected. Cathodic protection may be provided by sacrificial anodes or impressed current.
Cathodically Protected Noncoated Steel Tanks Or Piping	This option is only for steel tanks and piping installed before December 22, 1988. Cathodic protection is usually provided by an impressed current system.
Internal Lining Of Tanks	In the 2015 federal UST regulation, EPA revised the internal lining requirement; owners and operators must permanently close tanks using internal lining as the sole method of corrosion protection, if the internal lining fails the periodic inspection and cannot be repaired according to a code of practice. This option only pertained to steel tanks installed before December 22, 1988. A lining is applied to the inside of the tank. Does not apply to piping.
Combination Of Cathodically Protected Steel And Internal Lining Of Tanks	This option is only for steel tanks installed before December 22, 1988. Cathodic protection is usually provided by an impressed current system. Does not apply to piping.
Other Methods Used To Achieve Corrosion Protection	If you have tanks or piping that do not meet any of the descriptions above, check with your implementing agency to see if your UST system meets the requirements for corrosion protection. You also will need to ask about the operation, maintenance, and recordkeeping requirements applicable to this type of UST system.

UPDATED

Checklist For Corrosion Protection Systems Using Sacrificial Anodes Or Impressed Current

Corrosion Protection (Sacrificial Anode And Impressed Current Systems)	
Description	<p>Cathodic protection is one way to protect UST components from corrosion. Sacrificial anode systems have buried anodes attached to UST components; the anodes are more electrically active than steel, so they suffer the destructive effects of corrosion rather than the steel they are attached to.</p> <p>Impressed current systems use a rectifier to provide direct current through anodes to the tank or piping to achieve corrosion protection. The steel is protected because the current going to the steel overcomes the corrosion-causing current flowing away from it.</p> <p>Impressed current systems must also meet the additional requirements in the checklist on the following page.</p>
Perform These O&M Actions	<ul style="list-style-type: none"> <input type="checkbox"/> You must have a periodic test conducted by a qualified cathodic protection tester to make sure your cathodic protection system is adequately protecting your UST system. This test needs to be conducted: <ul style="list-style-type: none"> o Within six months of installation. o At least every three years after the previous test. o Within six months after any repairs to your UST system: <ul style="list-style-type: none"> ▪ Make sure the cathodic protection tester is qualified to perform the test and follows a standard code of practice to determine that test criteria are adequate. ▪ If any test indicates your tanks are not adequately protected, you must have a corrosion expert examine and fix your system. ▪ Testing more frequently can catch problems before they become big problems.
Keep These O&M Records	<ul style="list-style-type: none"> <input type="checkbox"/> You must keep the results of at least the last two tests. See pages 48-49 for a sample record for periodic testing of cathodic protection systems.

Checklist With Additional Requirements For Impressed Current Systems

Corrosion Protection (Additional Requirements For Impressed Current Systems)	
Description	<p>Impressed current systems use a rectifier to provide direct current through anodes to the tank or piping to achieve corrosion protection. The steel is protected because the current going to the steel overcomes the corrosion-causing current flowing away from it.</p> <p>Impressed current systems must also meet the requirements in the checklist on the previous page.</p>
Perform These O&M Actions	<ul style="list-style-type: none"> <input type="checkbox"/> You must inspect your rectifier at least every 60 days to make sure that it is operating within normal limits. <ul style="list-style-type: none"> ○ This inspection involves reading and recording the voltage and amperage readouts on the rectifier. You or your employees can perform this periodic inspection. ○ Make sure your corrosion expert provided you with the rectifier's acceptable operating levels so you can compare the readings you take with an acceptable operating level. If your readings are not within acceptable levels, you must contact a corrosion expert to address the problem. <input type="checkbox"/> You should have a trained professional periodically service your impressed current system. <input type="checkbox"/> Never turn off your rectifier. If your rectifier is off, your UST system is not protected from corrosion.
Keep These O&M Records	<ul style="list-style-type: none"> <input type="checkbox"/> You must keep records of at least the last three rectifier readings. See page 50 for a sample 60-day impressed current cathodic protection system inspections form.

Checklist For Internally Lined Tanks

Corrosion Protection (Internally Lined Tanks)	
Description	Tanks installed before December 22, 1988, were internally lined by trained professionals to meet the corrosion protection requirements.
Perform These O&M Actions	<ul style="list-style-type: none"> <input type="checkbox"/> Within 10 years after lining and at least every five years thereafter, the lined tank must be inspected by a trained professional and found to be structurally sound with the lining still performing according to original design specifications. Make sure the professional performing the inspection follows a standard code of practice. <input type="checkbox"/> You must permanently close tanks using internal lining as the sole method of corrosion protection, if the internal lining fails the periodic inspection and cannot be repaired according to a code of practice.
Keep These O&M Records	<ul style="list-style-type: none"> <input type="checkbox"/> Keep records of the inspection, as specified in industry standards for lining inspections.

UPDATED

Sample Record For Periodic Testing Of Cathodic Protection Systems (For Use By A Qualified Cathodic Protection Tester)

Test Date: ___/___/___ Facility Name/ID: _____

Note: Draw site sketch in the space provided on the next page.

Cathodic Protection (CP) Tester Information:

Name: _____ Phone Number: _____

Address: _____

A qualified CP tester must conduct testing. Indicate your qualifications as a CP tester:

Identify which of the following testing situations applies:

- Test required within six months of installation of CP system (installation date: ___/___/___)
- Periodic three year test
- Test required within six months of any repair activity – note repair activity and date below:
repair activity: _____ repair date: ___/___/___

Indicate which industry standard you used to determine that the cathodic protection test criteria are adequate:

Cathodic Protection Test Method Used (check one)

- 100 mV cathodic polarization test
- 850 mV test (circle one below)
 - Polarized potential (instant off)
 - Potential with CP applied, IR drop considered
- Note: All readings taken must meet the -850 mV criteria to pass
- Other accepted method (please describe):

Is the cathodic protection system working properly? Yes No (circle one)

If answer is no, go to the directions at the bottom of the next page.

My signature below affirms that I have sufficient education and experience to be a cathodic protection tester; I am competent to perform the tests indicated above; and that the results on this form are a complete and truthful record of all testing at this location on the date shown.

CP Tester Signature: _____ Date: _____

Keep this record for at least six years.

Site Sketch: Draw a rough sketch of the tanks and piping, the location of each CP test, and each voltage value obtained (use space below or attach separate drawing). Voltage readings through concrete or asphalt do not provide accurate readings and are not acceptable. Perform sufficient testing to evaluate the entire UST system.

If the CP system fails the test and is not working properly, you must have a corrosion expert investigate and fix the problem. A corrosion expert has additional training, skills, and certification beyond the corrosion tester who filled out the bulk of this form. A corrosion expert must be:

- Accredited or certified by NACE International-The Corrosion Society as a corrosion specialist or cathodic protection specialist, or
- A registered professional engineer with certification or licensing in corrosion control.

As long as you have the UST, be sure you keep a record that clearly documents what the corrosion expert did to fix your CP system.

Keep this record for at least six years.

What If You Combine Internal Lining And Cathodic Protection?

If you chose the combination of internal lining and cathodic protection for meeting corrosion protection requirements on your UST, you may not have to meet the periodic inspection requirement for the lined tank. However, you must always meet the requirements for checking and testing your cathodic protection system as described in the checklists on pages 45-46. The 10-year and subsequent five-year inspections of the lined tank are not required if the integrity of the tank was ensured when cathodic protection was added. You should be able to show an inspector documentation of the passed integrity assessment.

Example 1:

If cathodic protection and internal lining were applied to your tank at the same time, periodic inspections of the lined tank are not required because an integrity assessment of the tank is required prior to adding the cathodic protection and internal lining.

Example 2:

If cathodic protection was added to a tank in 1997 that was internally lined in 1994 and the contractor did not perform an integrity assessment of the tank at the time cathodic protection was added or you cannot show an inspector documentation of the passed integrity assessment, then periodic inspections of the lined tank are required. This is required because you cannot prove that the tank was structurally sound and free of corrosion holes when the cathodic protection was added. The lined tank needs to be periodically inspected because the lining may be the only barrier between your product and the surrounding environment.

Do All UST Sites Need Corrosion Protection?

A corrosion expert may be able to determine the soil at an UST site is not conducive to corrosion and will not cause the tank or piping to leak during its operating life. If so, you must keep a record of that corrosion expert's analysis for the life of the tank or piping to demonstrate why your UST has no corrosion protection.

Section 6: Walkthrough Inspections



UPDATED

No later than October 13, 2018, you must conduct your first walkthrough inspection. Below we provide details and frequency of the inspection.

Every 30 days

- Check your spill prevention equipment for damage and remove liquid or debris.
- Check for and remove obstructions in the fill pipe.
- Check the fill cap to ensure it is securely on the fill pipe.
- For double-walled spill prevention equipment with interstitial monitoring, check for a leak in the interstitial area.

Exception: if your UST system receives deliveries at intervals greater than 30 days, you may check your spill prevention equipment prior to each delivery.

- Check your release detection equipment to ensure it is operating with no alarms or unusual operating conditions present (for example ATG consoles or pressure or vacuum gauges). You do not have to check release detection equipment in containment sumps. Release detection equipment in these areas is tested annually.
- Review your release detection records and ensure they are current.

Annually

- Check your containment sumps for damage and leaks to the containment area or releases to the environment.
- Remove liquid in contained sumps or debris.
- For double-walled containment sumps with interstitial monitoring, check for leaks in the interstitial area.



Inspecting a containment sump

- **Check your hand-held release detection equipment, such as groundwater bailers and tank gauge sticks, for operability and serviceability.**

In addition, the 2015 federal UST regulation allows owners and operators to conduct O&M walkthrough inspections according to a standard code of practice developed by a nationally recognized association or independent testing laboratory or according to requirements developed by your implementing agency. The inspections must check equipment in a manner comparable to the walkthrough inspection requirements described above. Note that owners and operators must use the entire code of practice if choosing this option for meeting the walkthrough inspection requirement.

In addition to the requirements listed above, you may also want to perform these good site management practices during your walkthrough inspections:

- **Fill and monitoring ports:** Are covers and caps tightly sealed and locked?
- **Spill and overfill response supplies:** Do you have the appropriate supplies for cleaning up a spill or overfill?
- **Containment areas:** Is there significant corrosion on the UST equipment in these areas? Corrosion could result in equipment in the containment area not working properly.
- **Dispenser hoses, nozzles, and breakaways:** Are they in good condition and working properly?

If you find problems during the inspection, you or your UST contractor must take action quickly to resolve these problems and avoid serious releases.

See the sample walkthrough inspection checklist on the next page.

Sample Walkthrough Inspection Checklist

Date Of Inspection							
Required Every 30 Days (exception: if your UST system receives deliveries at intervals greater than 30 days, you may check your spill prevention equipment prior to each delivery.)							
Visually check spill prevention equipment for damage. Remove liquid or debris.							
Check for and remove obstructions in fill pipe.							
Check fill cap to ensure it is securely on fill pipe.							
For double-walled spill prevention equipment with interstitial monitoring, check for a leak in the interstitial area.							
Check release detection equipment to ensure it is operating with no alarms or unusual operating conditions present.							
Review and keep current release detection records.							
Required Annually							
Visually check containment sumps for damage and leaks to the containment area or releases to the environment.							
Remove liquid in contained sumps or debris.							
For double-walled containment sumps with interstitial monitoring, check for leaks in the interstitial area.							
Check hand-held release detection equipment, such as groundwater bailers and tank gauge sticks, for operability and serviceability.							
Recommended Activities							
Fill and monitoring ports: Inspect all fill or monitoring ports and other access points to make sure that the covers and caps are tightly sealed and locked.							
Spill and overfill response supplies: Inventory and inspect the emergency spill response supplies. If the supplies are low, restock the supplies. Inspect supplies for deterioration and improper functioning.							
Containment sump areas: Look for significant corrosion on the UST equipment.							
Dispenser hoses, nozzles, and breakaways: Inspect for loose fittings, deterioration, obvious signs of leaks, and improper functioning.							

Your initials in each box below the date of the inspection indicate the device or system was inspected and satisfactory on that date.

In the following table, explain actions taken to fix issues.

Date	Action Taken

Keep this record for at least one year after last inspection date on the form.

Section 7: For More Information



Government Links

- U.S. Environmental Protection Agency's Office of Underground Storage Tanks: www.epa.gov/ust. EPA's UST compliance assistance: www.epa.gov/ust/resources-owners-and-operators
- State UST program contact information: www.epa.gov/ust/underground-storage-tank-ust-contacts#states
- Tanks Subcommittee of the Association of State and Territorial Solid Waste Management Officials (ASTSWMO): www.astswmo.org
- New England Interstate Water Pollution Control Commission (NEIWPCC): www.neiwpcc.org

Industry Codes And Standards

www.epa.gov/ust/underground-storage-tanks-usts-laws-regulations#code

Other Organizations To Contact For UST Information

www.epa.gov/ust/underground-storage-tank-ust-contacts#other



United States Environmental Protection Agency
5401R
Washington, DC 20460

EPA 510-K-16-001
February 2016